

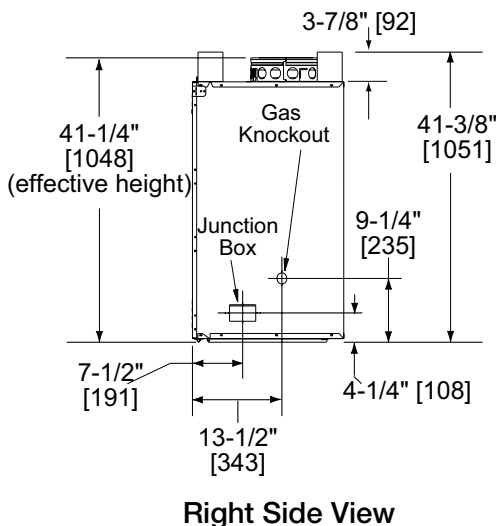

Please consult the manufacturer's installation manual for all details and requirements before making a final design layout decision.

Accelerator 42" Wood Fireplace

MODEL	FRONT WIDTH		BACK WIDTH		HEIGHT		DEPTH		FIREPLACE OPENING
	Actual	Framing	Actual	Framing	Actual	Framing	Actual	Framing	
A42C/A42R	48	49	30-7/8	49	41-3/8	41-1/2	22-3/4	23	42 x 23-3/8

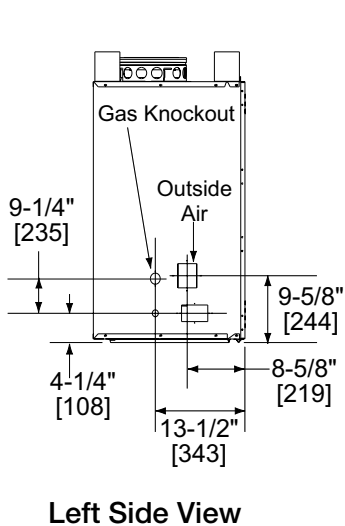
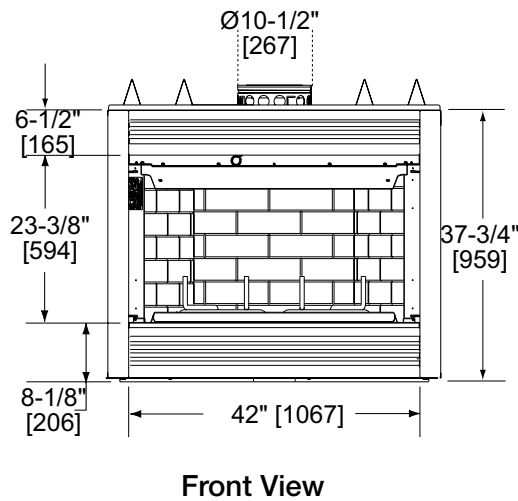
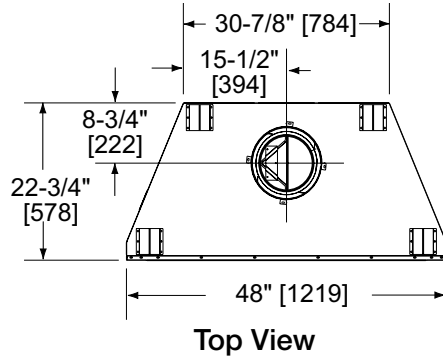

APPLIANCE LOCATION

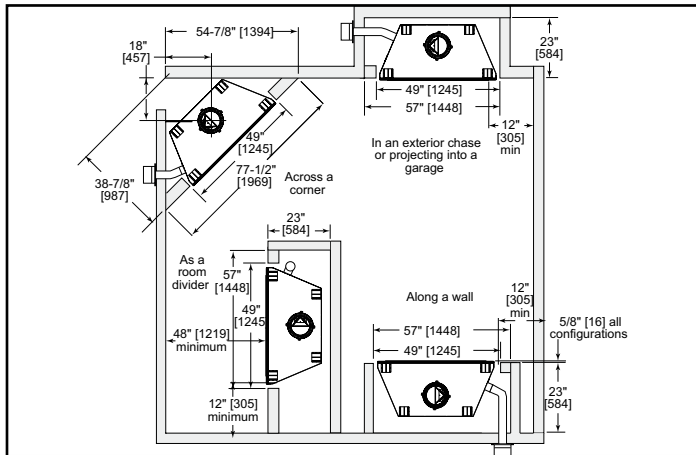

MANTEL PROJECTIONS

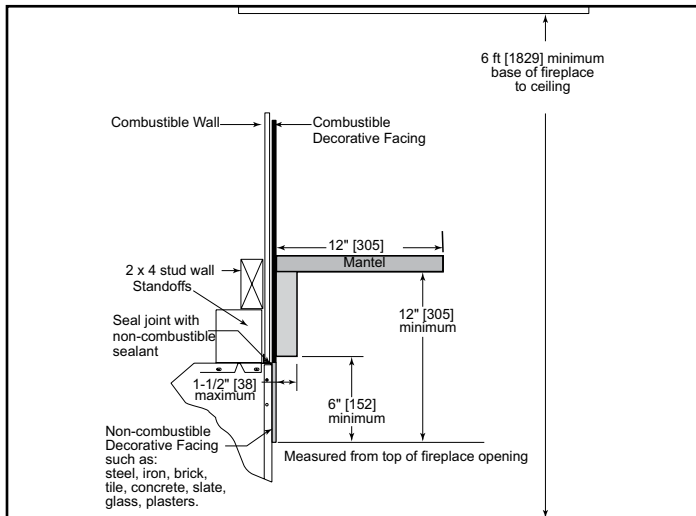

MANTEL LEG/WALL PROJECTIONS

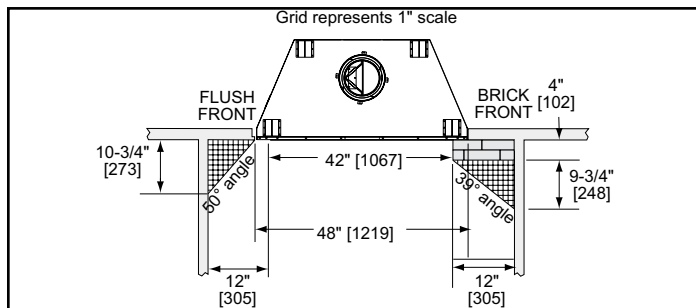

HEARTH EXTENSIONS

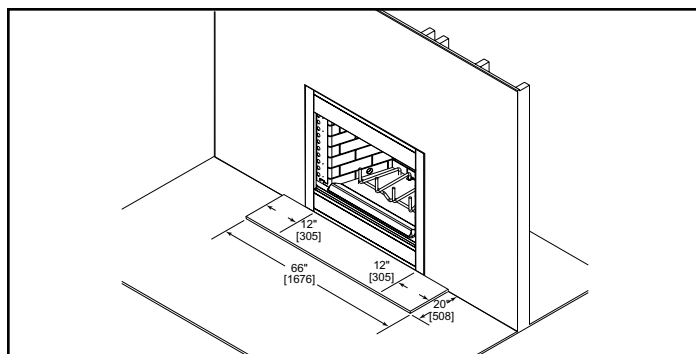

FRAMING DIMENSIONS

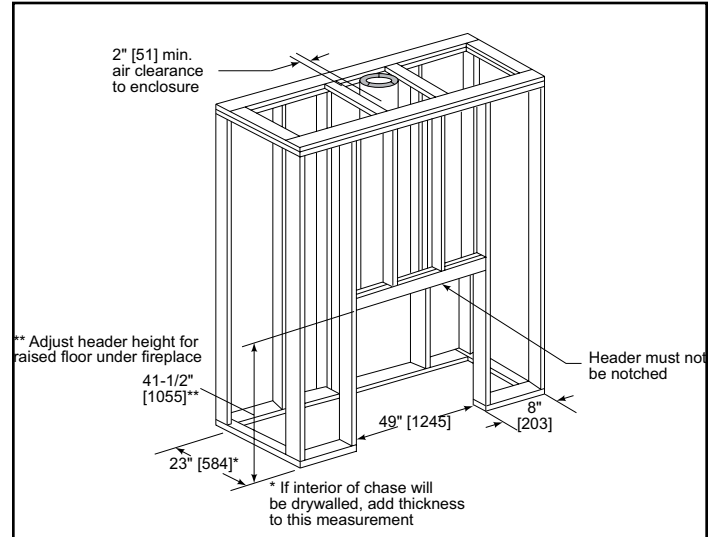

CLEARANCES TO COMBUSTIBLES

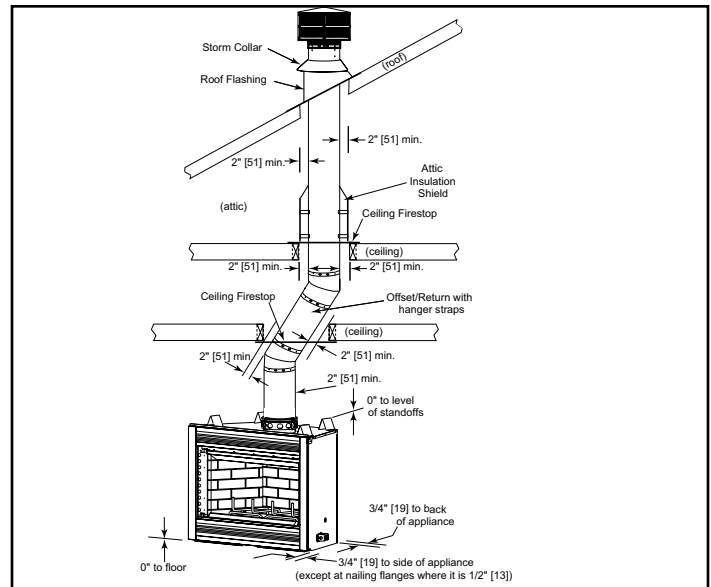

HEARTH EXTENSION CONSTRUCTION

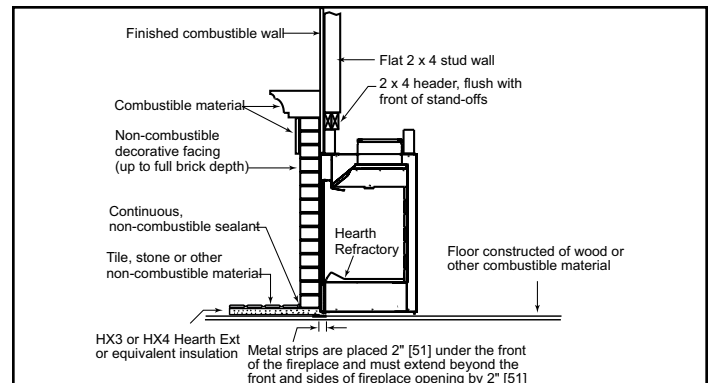

PRODUCT LISTING CODES

US	UL 127
CAN	ULC-S610

Product information provided is not complete and is subject to change without notice. Product installation must adhere strictly to instructions accompanying product to avoid risk of fire and potential injury.

Additional information can be found online at www.heatilator.com